

# CATÁLOGO DE PRODUTOS

## ORGULHO EM PERTENCER.

Ter paixão e profissionalismo faz com que a **Central de Embalagens** seja muito além de produzir produtos plásticos, temos orgulho em trazer soluções completas para os clientes.

**Há mais de 30 anos no mercado**, a Central de Embalagens é referência no setor de produtos plásticos. Nosso foco é proporcionar a melhor experiência com nossos produtos. Contamos com quatro unidades próprias localizadas estrategicamente em Boituva/SP, Osasco/SP, Alagoinhas/BA e Contagem/MG, totalizando uma **capacidade produtiva superior a 2.000 toneladas por mês**.

Valorizamos a experiência dos nossos clientes ao usar nossos produtos. Por isso, oferecemos **opções de personalização e realizamos rigorosos controles de qualidade** em nosso laboratório próprio, assegurando a excelência do início ao fim. Possuímos certificação ISO 9001:2015 e todos os nossos produtos compulsórios são aprovados pelo Inmetro.



# Avicultura

## FRANGO CONGELADO

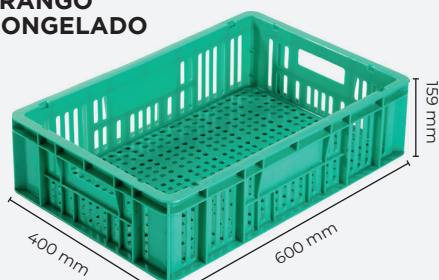

Capacidade: 29 l<sup>\*</sup>  
Carga por Caixa: 20 kg<sup>\*</sup>  
Peso: 1,82 kg (± 3%)

## CTO

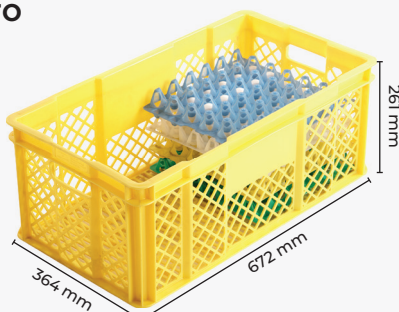

Capacidade: 51 l<sup>\*</sup>  
Carga por Caixa: 20 kg<sup>\*</sup>  
Peso: 2,10 kg (± 3%)

## BANDEJA DE OVOS

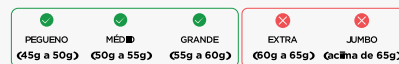
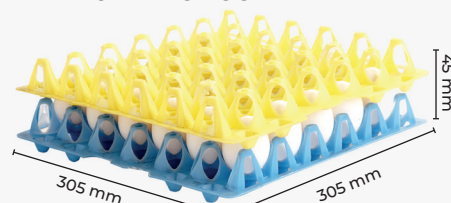

Capacidade: 30 ovos  
Peso: 0,155 kg (± 3%)  
Para ovos até tipo grande (até 60 g)

## GAIOLA BAIXA

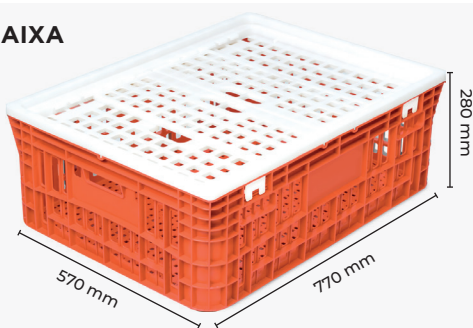

Capacidade: 100 l<sup>\*</sup>  
Carga por Caixa: 40 kg<sup>\*</sup>  
Peso 6 kg (± 3%)

## GAIOLA ALTA

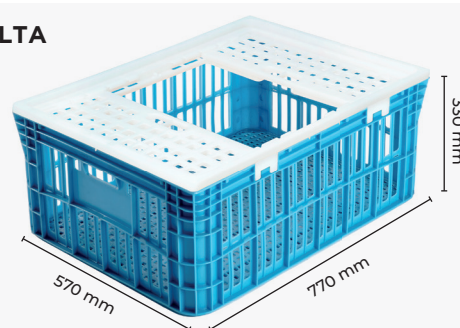

Capacidade: 115 l<sup>\*</sup>  
Carga por Caixa: 40 kg<sup>\*</sup>  
Peso 6 kg (± 3%)

# Agricultura e Alimentos

## MF 5

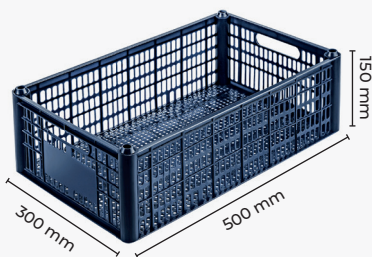

Capacidade: 21,2 l<sup>\*</sup>  
Carga por Caixa: 8 kg<sup>\*</sup>  
Peso: 0,47 kg (± 3%)

## MF 23

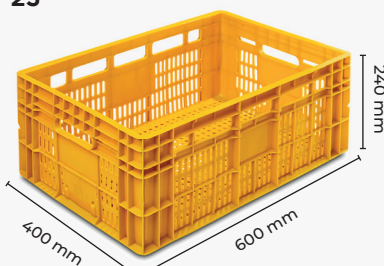

Capacidade: 45 l<sup>\*</sup>  
Carga por Caixa: 25 kg<sup>\*</sup>  
Peso: 2,00 kg (± 3%)

## MF 6

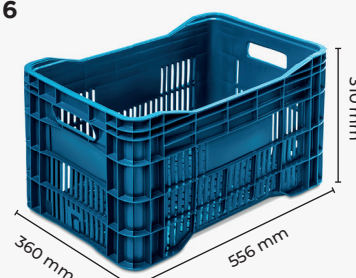

Capacidade: 49 l<sup>\*</sup>  
Carga por Caixa: 30 kg<sup>\*</sup>  
Peso: 1,90 kg (± 3%)

## MF 2



Capacidade: 50 l<sup>\*</sup>  
Carga por Caixa: 32 kg<sup>\*</sup>  
Peso: 2,00 kg (± 3%)

## MF 8

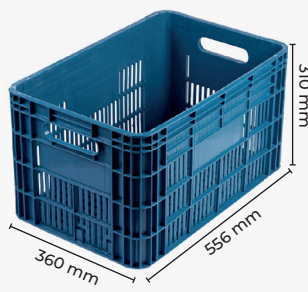

Capacidade: 50 l<sup>\*</sup>  
Carga por Caixa: 33 kg<sup>\*</sup>  
Peso: 2,00 kg (± 3%)

## CE 15

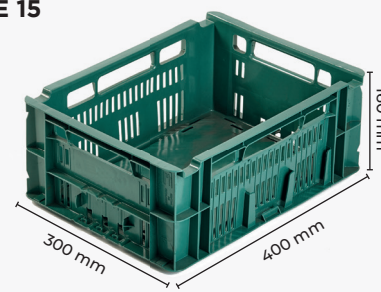

Capacidade: 14 l<sup>\*</sup>  
Carga por Caixa: 5 kg<sup>\*</sup>  
Peso: 0,85 kg (± 3%)



**CE 21**

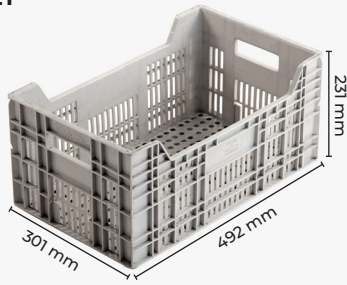

Capacidade: 22 l\*  
Carga por Caixa: 17 kg\*  
Peso: 1,34 kg (± 3%)

**CE 18F**

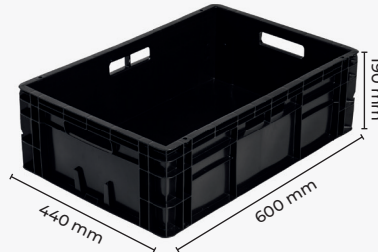

Capacidade: 36 l\*  
Carga por Caixa: 22 kg\*  
Peso: 2,00 kg (± 3%)

**CE 17**

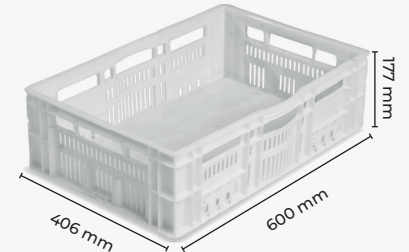

Capacidade: 37 l\*  
Carga por Caixa: 15 kg\*  
Peso: 1,67 kg (± 3%)

**CE 20**

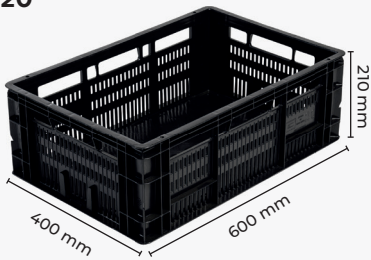

Capacidade: 39 l\*  
Carga por Caixa: 22 kg\*  
Peso: 2,00 kg (± 3%)

**CE 23**

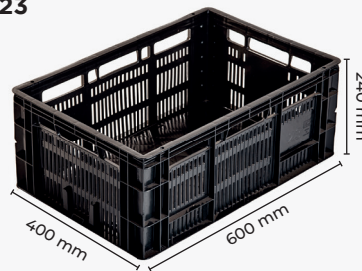

Capacidade: 45 l\*  
Carga por Caixa: 25 kg\*  
Peso: 2,00 kg (± 3%)

**CTAIG 200 TF**



Capacidade: 38 l\*  
Carga por Caixa: 25 kg\*  
Peso: 2,18 kg (± 3%)

**CTAIG 200 TA**

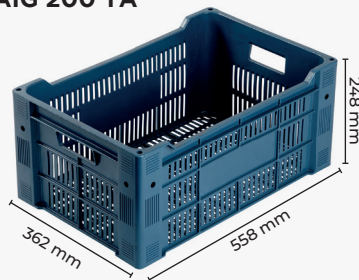

Capacidade: 38 l\*  
Carga por Caixa: 25 kg\*  
Peso: 1,88 kg (± 3%)

**CTAIG 101**

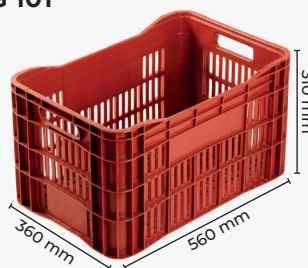

Capacidade: 49 l\*  
Carga por Caixa: 30 kg\*  
Peso: 2,10 kg (± 3%)

**FRANGÃO VAZADO**



Capacidade: 47 l\*  
Carga por Caixa: 30 kg\*  
Peso: 2,02 kg (± 3%)

**BANDEJA DE PÃES**

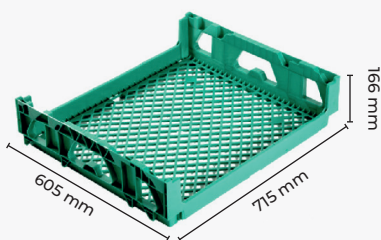

Capacidade: 40 l\*  
Carga por Caixa: 8 kg\*  
Peso: 2,25 kg (± 3%)

**BR 1000 BAIXA**

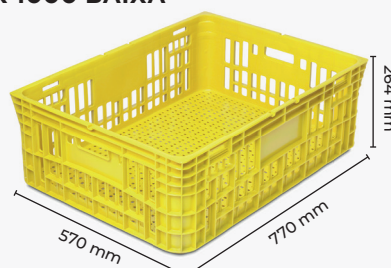

Capacidade: 92 l\*  
Carga por Caixa: 40 kg\*  
Peso: 3,80 kg (± 3%)

**BR 1000 ALTA**

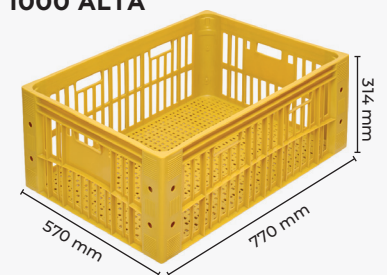

Capacidade: 116 l\*  
Carga por Caixa: 40 kg\*  
Peso: 4,10 kg (± 3%)

# Pescados

## CIC 20 CAIXA DE CAMARÃO

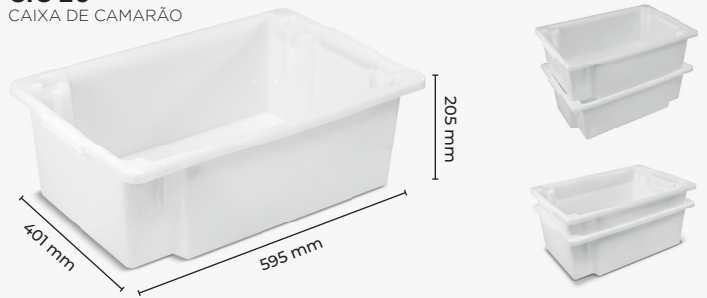

Capacidade: 37 l\* / Carga por Caixa: 22 kg\*  
(20 kg de camarão e 2 kg de gelo)  
Peso: 1,55Kg (+-3%)

## CIP 25 CAIXA DE PESCADO

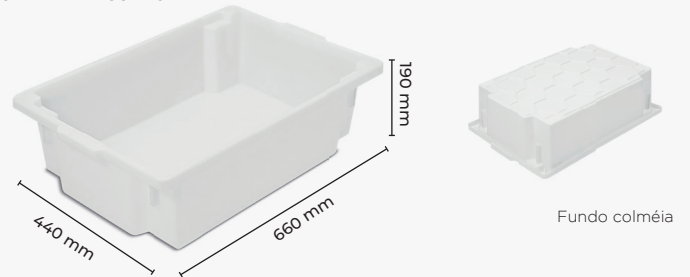

Capacidade: 40 l\*  
Carga por Caixa: 25 kg\*  
Peso: 1,80 kg (± 3%)

# Multiuso

## CE 24

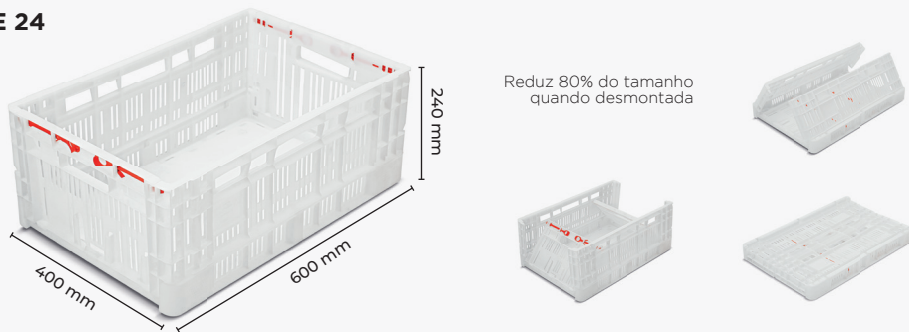

Capacidade: 45 l\*  
Carga por Caixa: 35 kg\*  
Peso: 2,064 kg (± 3%)

## CESTA FEIRA



Capacidade: 14 l\*  
Carga por Caixa: 10 kg\*  
Peso: 0,59 kg (sem alça) 0,828 kg (com alça)

## FLAT BOX

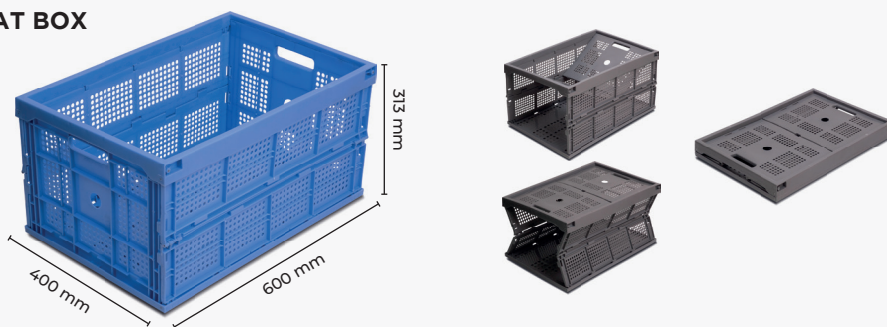

Capacidade: 64 l\*  
Carga por Caixa: 15 kg\*  
Peso: 2,50 kg (± 3%)

## CE 35

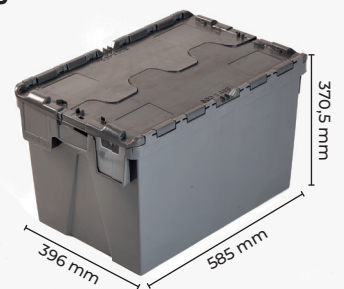

Capacidade: 70 l\*  
Carga por Caixa: 30 kg\*  
Peso: 3,54 kg (± 3%)

## DRY DECK

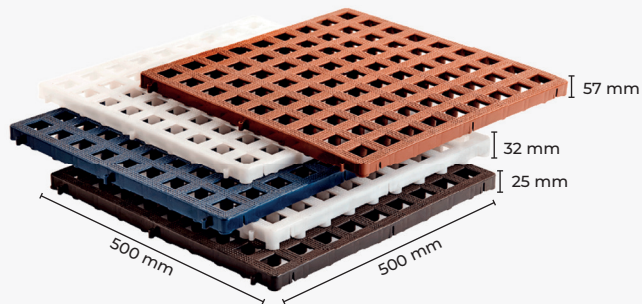

**Modelo 1:**  
Altura: 25 mm  
Peso: 0,762 kg (± 3%)

**Modelo 2:**  
Altura: 32 mm  
Peso: 0,822 kg (± 3%)

**Modelo 3:**  
Altura: 57 mm  
Peso: 1,123 kg (± 3%)

## CTM CAIXA PARA MINÉRIOS

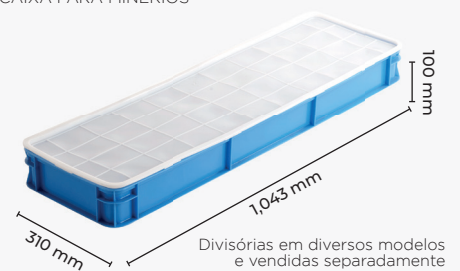

Capacidade: 20,8 l\*  
Carga por Caixa: 15 kg\*  
Peso: 2,65 kg (± 3%)



## CADEIRA BISTRÔ SÓLIDA



Suporta até 182 kg  
Peso: 2,30 kg (± 3%)  
Área de Gravação (silk): 14 x 14 cm

## CADEIRA BISTRÔ VAZADA



Suporta até 182 kg  
Peso: 2,25 kg (± 3%)

## POLTRONA PÉGASUS



Suporta até 182 kg  
Peso: 2,75 kg (± 3%)  
Área de Gravação (silk): 17 x 25 cm

## MESA QUADRADA MONOBLOCO

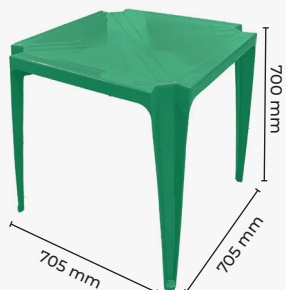

Área de Gravação (silk):  
Tampo: 4 partes de 15 x 15 cm | Lateral: 34 x 3 cm (4 lados)  
Peso: 3,85 kg (± 3%)



# Garrafeiras

**CTG 9**

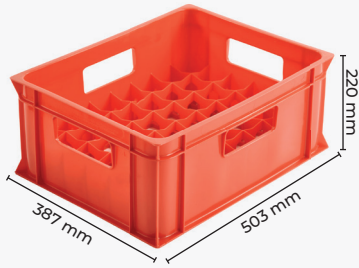

48 garrafas de 200 ml  
Peso: 1,90 kg (± 3%)

**CTG 3**

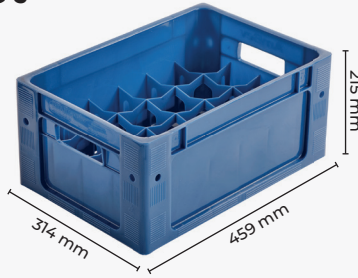

24 garrafas de 300 ml  
Peso: 1,60 kg (± 3%)

**CTG 3B**

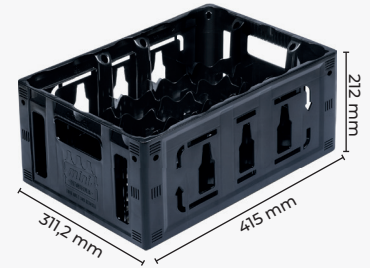

23 garrafas de 300 ml  
Peso: 1,62 kg (± 3%)

**CTG 4**

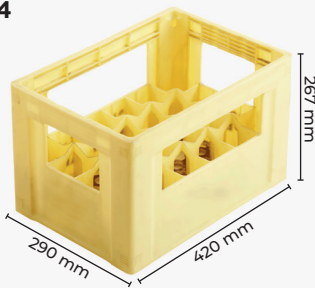

24 garrafas de 300 ml  
Peso: 1,65 kg (± 3%)

**CTG 7**

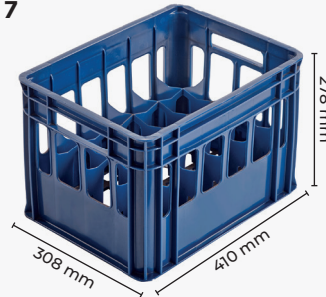

24 garrafas de 300 ml  
(Parede Alta)  
Peso: 1,60 kg (± 3%)

**CTG 10 KS ULTRA**

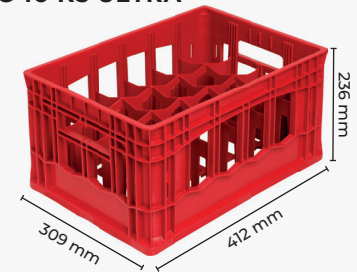

24 garrafas de 290 ml  
(Parede Alta)  
Peso: 1,44 kg (± 3%)

**CTG 1**



24 garrafas de 600 ml  
Peso: 2,68 kg (± 3%)

**CTG 2**

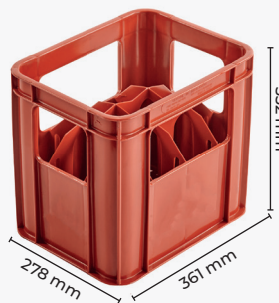

12 garrafas de 600 ml ou 1 l  
Peso: 1,60 kg (± 3%)

**CTG 15**

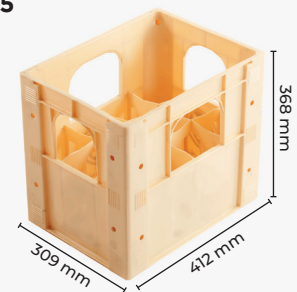

12 garrafas de 1 l  
Peso: 2,20 kg (± 3%)

**CTG 17**

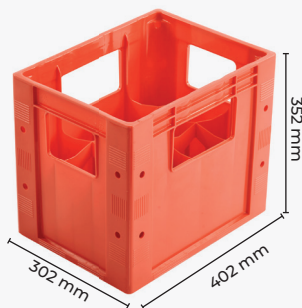

12 garrafas de 1 l  
Peso: 2,25 kg (± 3%)

**CTG 13**

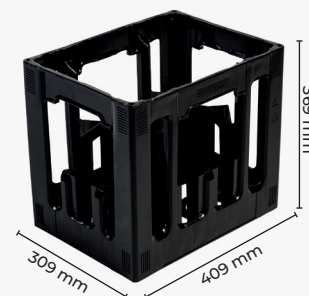

12 garrafas de 1,5 l  
Peso: 2,30 kg (± 3%)



CTG 16

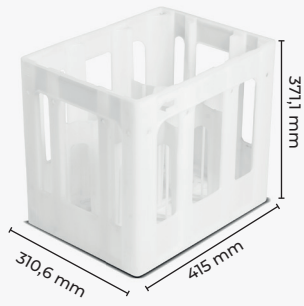

9 garrafas de 2 l  
 Peso: 2,30 kg (± 3%)

CTG 20

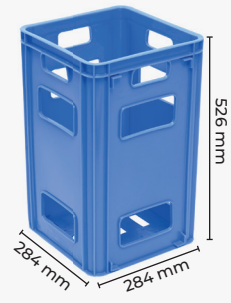

Garrafão (18 a 20 l)  
 Peso: 2,14 kg (± 3%)



**Térmicos**

LATAS



269 ml

355 ml

473 ml

LITRINHO



300 ml

BINECK



355 ml

MOD. 1



MOD. 2



MOD. 3



MOD. 4



600 ml

MOD. 1



MOD. 3



LITRÃO



Litro

## Paleta Estrado

### ESTRADO SMART

ED 2525

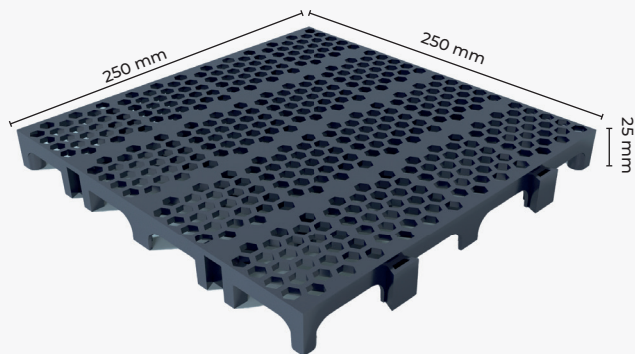

**Peso:** 0,200 kg  
**Carga Estática:** 5.000 kg  
**Quantidade Necessária para 1 m<sup>2</sup>:** 16 unidades

### ESTRADO HEAVY

ED 5050

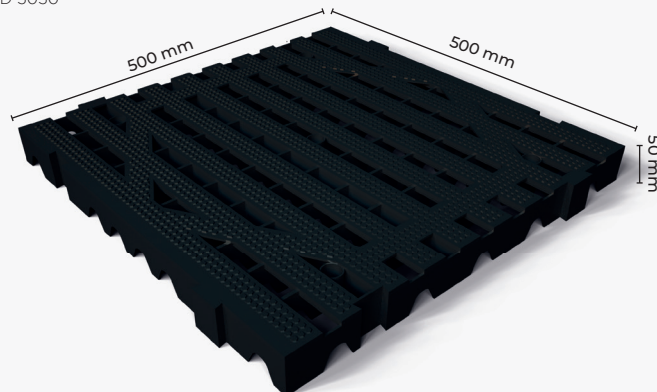

**Peso:** 1,2 kg  
**Carga Estática:** 10.000 kg  
**Quantidade Necessária para 1 m<sup>2</sup>:** 4 unidades

### ESTRADO MULTI

ED 2550

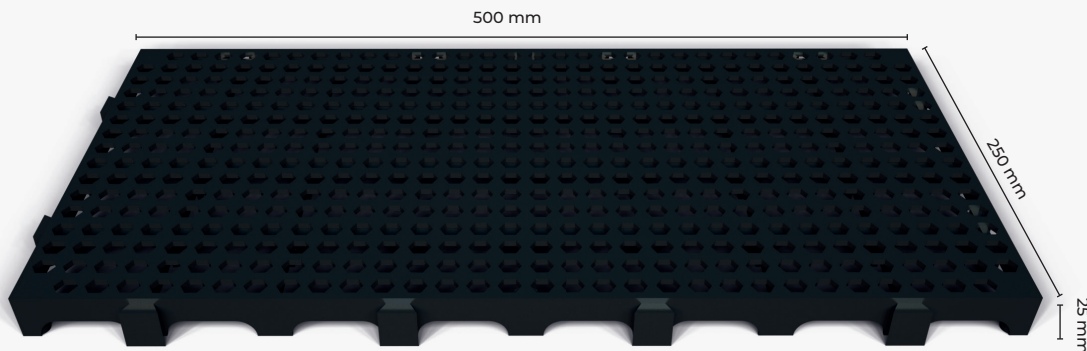

**Carga Estática:** 3.500 kg  
**Quantidade Necessária para 1 m<sup>2</sup>:** 8 unidades  
**Peso:** 0,380 kg

## Paleta Leve

### ESTRADO EXPORTAÇÃO

EX 1210

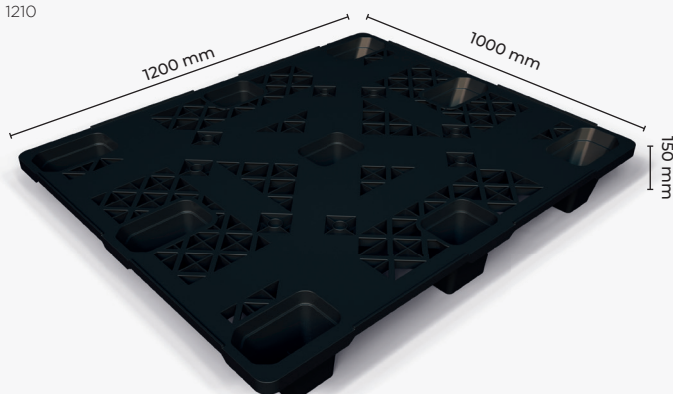

**Peso:** 8.5 kg  
**Carga Estática:** 2.500 kg  
**Carga Dinâmica:** 1.200 kg

### ESTRADO EXPORTAÇÃO LISO

EXLS 1210

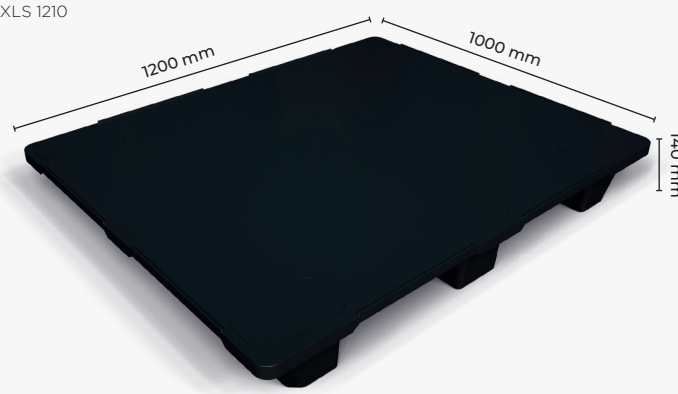

**Peso:** 9.1 kg  
**Carga Estática:** 3.000 kg  
**Carga Dinâmica:** 1.250 KG



## Paleta Médio

**PALETE MULTI**  
MD 1210

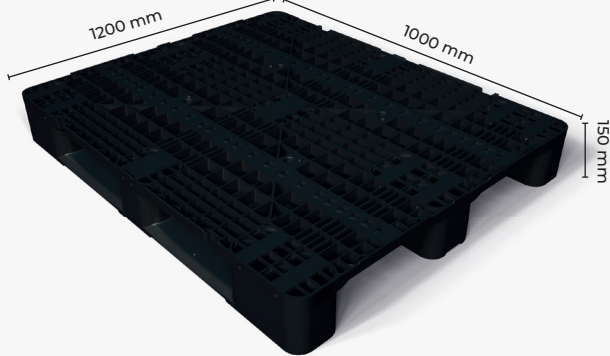

**Carga Estática:** 6.000 kg  
**Peso:** 15 kg

**Carga Dinâmica:** 1.250 kg  
**Carga Rack:** 800 kg

**PALETE MULTI LISO**  
MDLS 1210

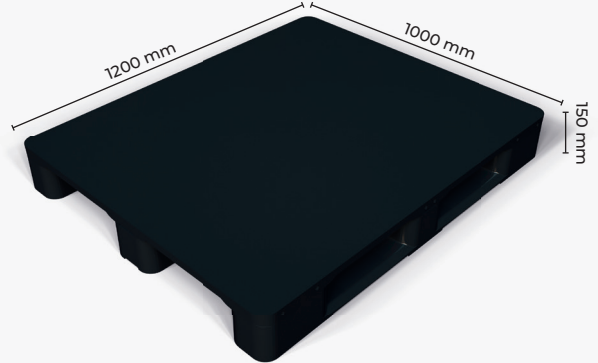

**Carga Estática:** 7.000 kg  
**Peso:** 19 kg

**Carga Dinâmica:** 2.000 kg  
**Carga Rack:** 900 kg

## Paleta Pesado

**PALETE PESADO 3R**  
HV3 1210

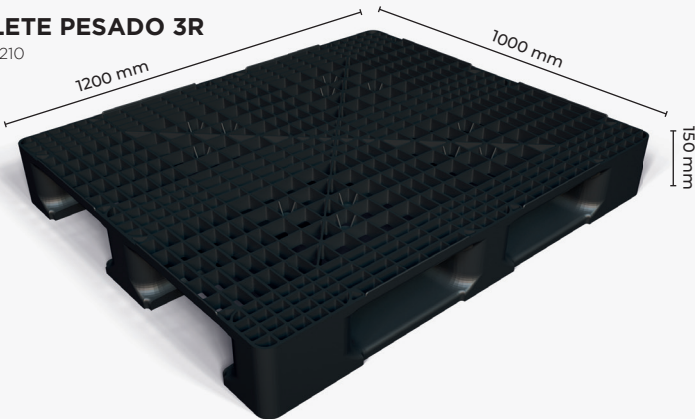

**Carga Estática:** 7.500 kg  
**Peso:** 15 kg

**Carga Dinâmica:** 2.500 kg  
**Carga Rack:** 850 kg

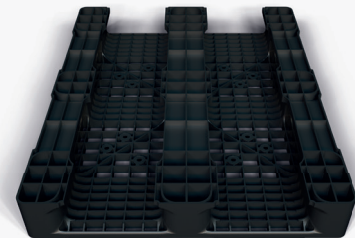

**PALETE PESADO 6R**  
HV6 1210

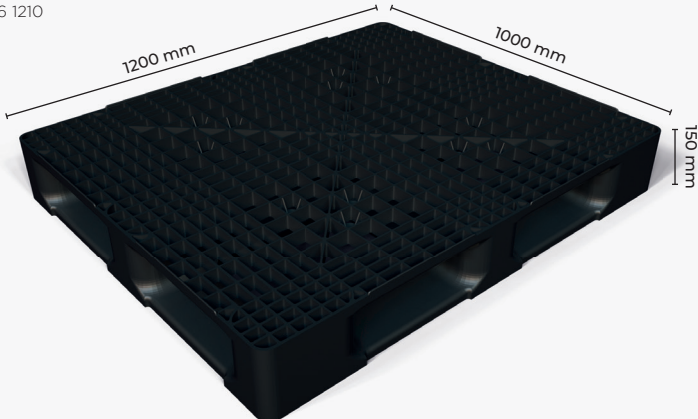

**Carga Estática:** 8.000 kg  
**Peso:** 16,5 kg

**Carga Dinâmica:** 3.000 kg  
**Carga Rack:** 1.000 kg



# Paleta de Contenção

## PALETE DE CONTENÇÃO 1T

CT1 TA

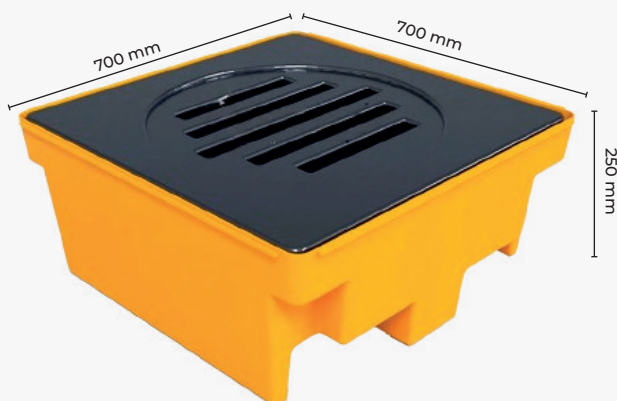

Capacidade: 110 l

## PALETE DE CONTENÇÃO 2T

CT2 TA

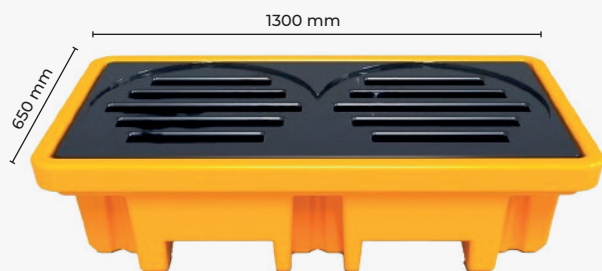

### Perfil Baixo

Dimensões: 1300 x 650 x 230 mm

Capacidade: 110 l

### Perfil Médio

Dimensões: 1300 x 650 x 320 mm

Capacidade: 190 l

### Perfil Alto

Dimensões: 1300 x 650 x 450 mm

Capacidade: 255 l

## PALETE DE CONTENÇÃO 4T

CT4 TA

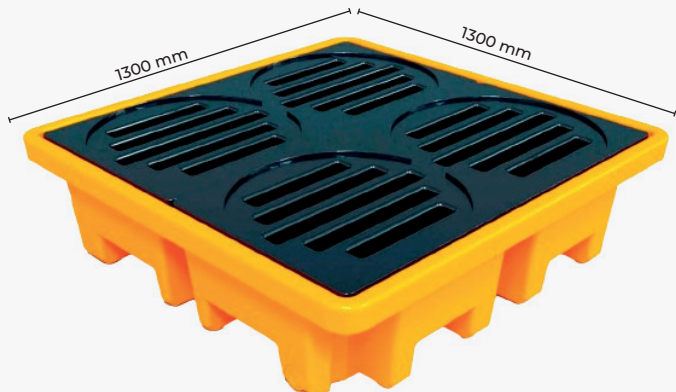

### Perfil Baixo

Dimensões: 1300 x 1300 x 230 mm

Capacidade: 220 l

### Perfil Médio

Dimensões: 1300 x 1300 x 320 mm

Capacidade: 380 l

### Perfil Alto

Dimensões: 1300 x 1300 x 450 mm

Capacidade: 420 l







# CENTRAL DE EMBALAGENS

---

ORGULHO EM PERTENCER

 [www.centraldeembalagens.com.br](http://www.centraldeembalagens.com.br)



## CONTATO

 (11) 98901-9276     (11) 3687-0311

 [comercial@centraldeembalagens.com.br](mailto:comercial@centraldeembalagens.com.br)

---

## ENDEREÇO

 **MATRIZ:** Rua Francisco Alves, 7 - Vila São José - Osasco - SP

 **BOITUVA:** Rua Benedito Mazulquim, 620 - Cidade Jardim - Boituva - SP

 **MINAS GERAIS:** Rua das Orquídeas, 290 - Contagem - MG

 **BAHIA:** Rod. Governador Mário Covas, S/N - Bairro 2 de Julho - Alagoinhas - BA

---

## REDES SOCIAIS

 @centraldeembalagens

 CE - Central de Embalagens

 [facebook.com/centraldeembalagens](https://facebook.com/centraldeembalagens)