

CATÁLOGO DE PRODUTOS



ORGULHO EM PERTENCER.

Ter paixão e profissionalismo faz com que a **Central de Embalagens** seja muito além de produzir produtos plásticos, temos orgulho em trazer soluções completas para os clientes.

Há mais de 30 anos no mercado, a Central de Embalagens é referência no setor de produtos plásticos. Nosso foco é proporcionar a melhor experiência com nossos produtos. Contamos com três unidades próprias localizadas estrategicamente em Boituva/SP, Osasco/SP e Alagoinhas/BA, totalizando uma **capacidade produtiva superior a 2.000 toneladas por mês.**

Valorizamos a experiência dos nossos clientes ao usar nossos produtos. Por isso, oferecemos **opções de personalização e realizamos rigorosos controles de qualidade** em nosso laboratório próprio, assegurando a excelência do início ao fim. Possuímos certificação ISO 9001:2015 e todos os nossos produtos compulsórios são aprovados pelo Inmetro.



Avicultura

FRANGO CONGELADO

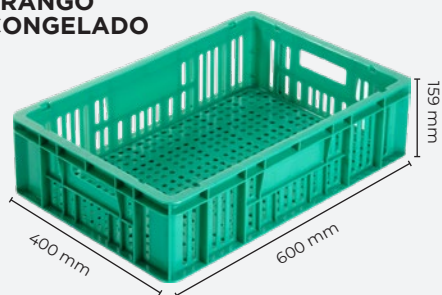

Capacidade: 29 l*
Carga por Caixa: 20 kg*
Peso: 1,82 kg (± 3%)

CTO

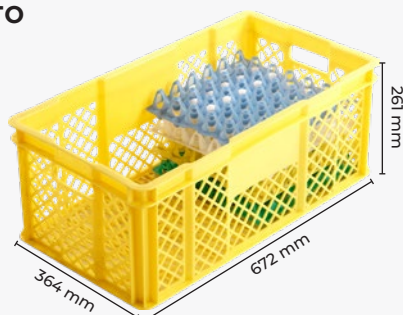

Capacidade: 51 l*
Carga por Caixa: 20 kg*
Peso: 2,10 kg (± 3%)

BANDEJA DE OVOS

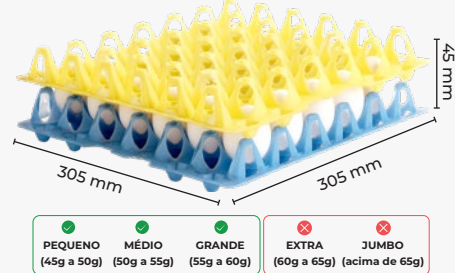

Capacidade: 30 ovos
Peso: 0,155 kg (± 3%)
Para ovos até tipo grande (até 60 g)

GAIOLA BAIXA

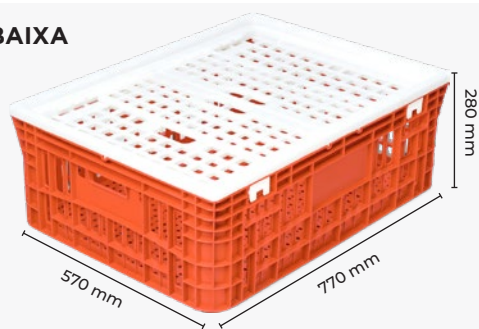

Capacidade: 100 l*
Carga por Caixa: 40 kg*
Peso 6 kg (± 3%)

GAIOLA ALTA

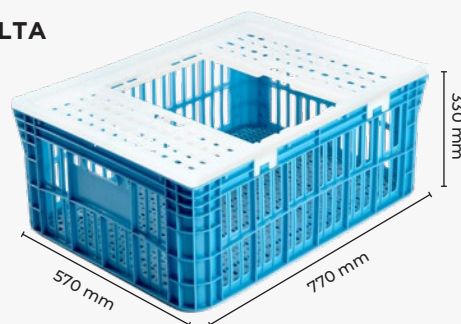

Capacidade: 115 l*
Carga por Caixa: 40 kg*
Peso 6 kg (± 3%)

Agricultura e Alimentos

MF 5

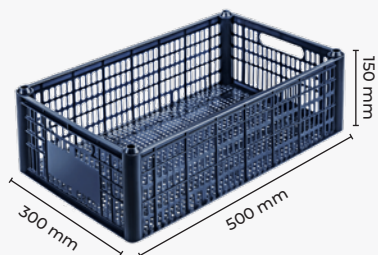

Capacidade: 21,2 l*
Carga por Caixa: 8 kg*
Peso: 0,47 kg (± 3%)

MF 23

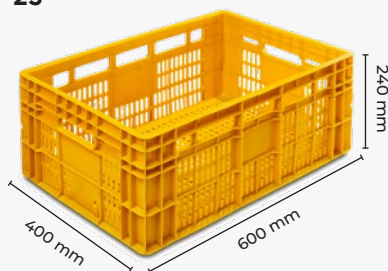

Capacidade: 45 l*
Carga por Caixa: 25 kg*
Peso: 2,00 kg (± 3%)

MF 6

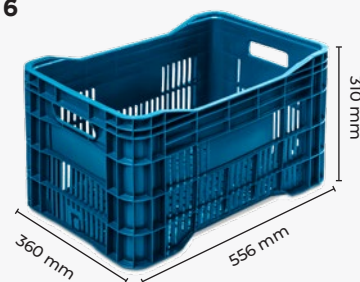

Capacidade: 49 l*
Carga por Caixa: 30 kg*
Peso: 1,90 kg (± 3%)

MF 2



Capacidade: 50 l*
Carga por Caixa: 32 kg*
Peso: 2,00 kg (± 3%)

MF 8

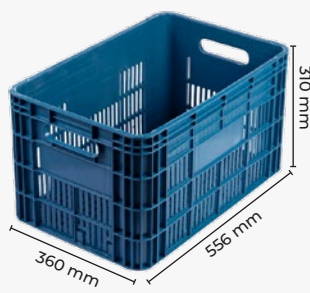

Capacidade: 50 l*
Carga por Caixa: 33 kg*
Peso: 2,00 kg (± 3%)

CE 15

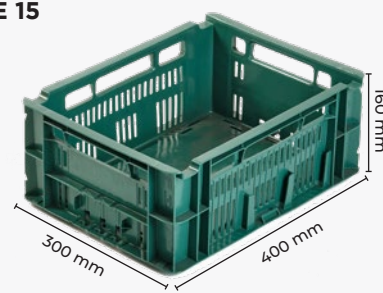

Capacidade: 14 l*
Carga por Caixa: 5 kg*
Peso: 0,85 kg (± 3%)

CE 21

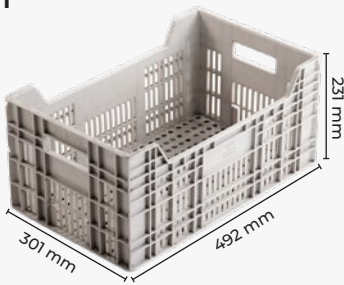

Capacidade: 22 l*
Carga por Caixa: 17 kg*
Peso: 1,34 kg (± 3%)

CE 18F

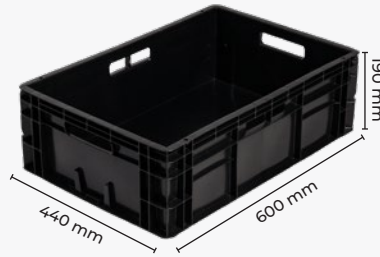

Capacidade: 36 l*
Carga por Caixa: 22 kg*
Peso: 2,00 kg (± 3%)

CE 17

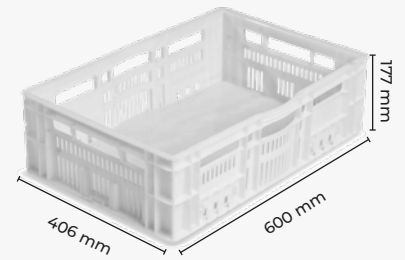

Capacidade: 37 l*
Carga por Caixa: 15 kg*
Peso: 1,67 kg (± 3%)

CE 20

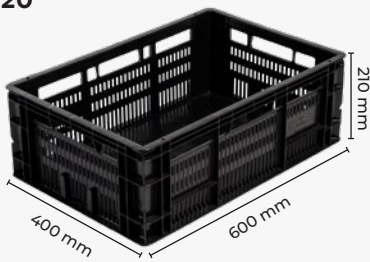

Capacidade: 39 l*
Carga por Caixa: 22 kg*
Peso: 2,00 kg (± 3%)

CE 23

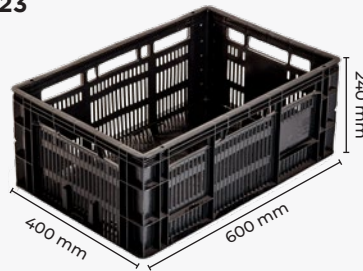

Capacidade: 45 l*
Carga por Caixa: 25 kg*
Peso: 2,00 kg (± 3%)

CTAIG 200 TF



Capacidade: 38 l*
Carga por Caixa: 25 kg*
Peso: 2,18 kg (± 3%)

CTAIG 200 TA

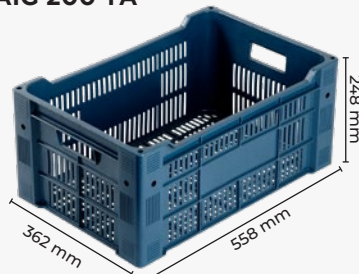

Capacidade: 38 l*
Carga por Caixa: 25 kg*
Peso: 1,88 kg (± 3%)

CTAIG 101



Capacidade: 49 l*
Carga por Caixa: 30 kg*
Peso: 2,10 kg (± 3%)

FRANGÃO VAZADO



Capacidade: 47 l*
Carga por Caixa: 30 kg*
Peso: 2,02 kg (± 3%)

BANDEJA DE PÃES

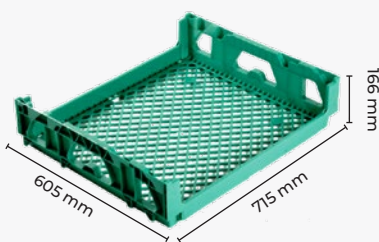

Capacidade: 40 l*
Carga por Caixa: 8 kg*
Peso: 2,25 kg (± 3%)

BR 1000 BAIXA

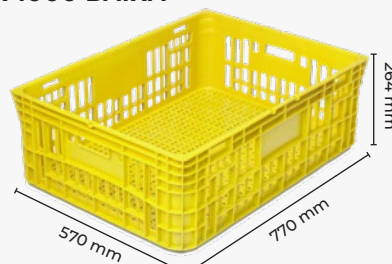

Capacidade: 92 l*
Carga por Caixa: 40 kg*
Peso: 3,80 kg (± 3%)

BR 1000 ALTA

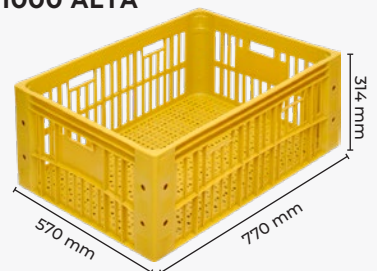

Capacidade: 116 l*
Carga por Caixa: 40 kg*
Peso: 4,10 kg (± 3%)

Pescados

CIC 20 CAIXA DE CAMARÃO

Duas opções de empilhamento

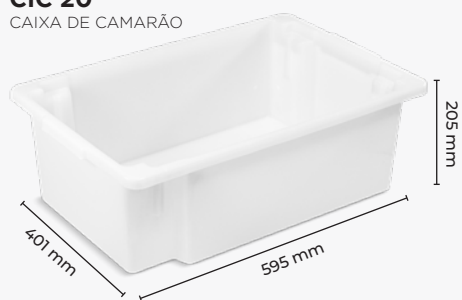

Capacidade: 37 l* / Carga por Caixa: 22 kg*
(20 kg de camarão e 2 kg de gelo)
Peso: 1,55Kg (+-3%)

CIP 25 CAIXA DE PESCAÇO

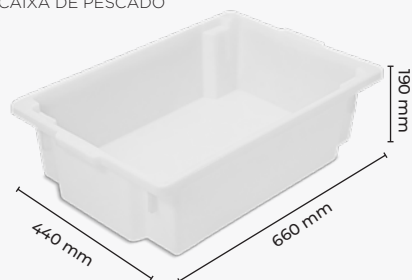

Fundo colméia

Capacidade: 40 l*
Carga por Caixa: 25 kg*
Peso: 1,625 kg (± 5%)

Multiuso

CE 24

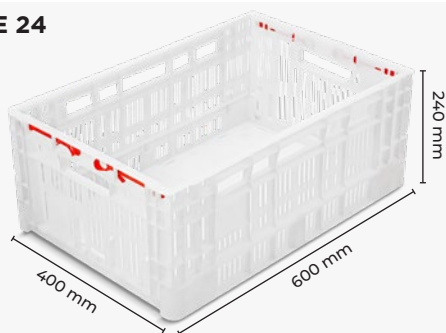

Reduz 80% do tamanho quando desmontada



Capacidade: 45 l*
Carga por Caixa: 35 kg*
Peso: 2,064 kg (± 3%)

CESTA FEIRA



Capacidade: 14 l*
Carga por Caixa: 10 kg*
Peso: 0,59 kg (sem alça) 0,828 kg (com alça)

FLAT BOX

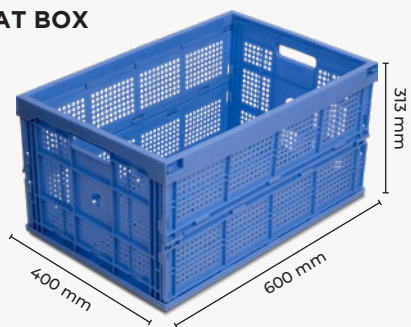

Capacidade: 64 l*
Carga por Caixa: 15 kg*
Peso: 2,50 kg (± 3%)

CE 35

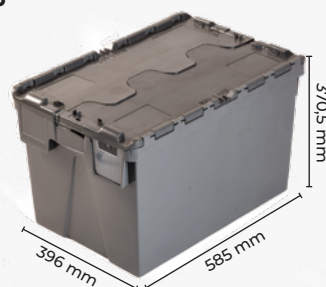

Capacidade: 70 l*
Carga por Caixa: 30 kg*
Peso: 3,54 kg (± 3%)

DRY DECK

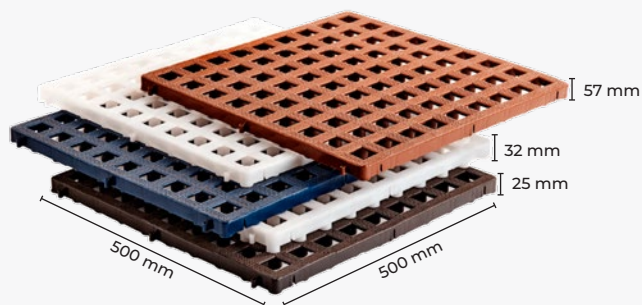

CTM CAIXA PARA MINÉRIOS



Divisórias em diversos modelos e vendidas separadamente

Modelo 1:
Altura: 25 mm
Peso: 0,762 kg (± 3%)

Modelo 2:
Altura: 32 mm
Peso: 0,822 kg (± 3%)

Modelo 3:
Altura: 57 mm
Peso: 1,123 kg (± 3%)

Capacidade: 20,8 l*
Carga por Caixa: 15 kg*
Peso: 2,65 kg (± 3%)

CADEIRA BISTRÔ SÓLIDA



Suporta até 182 kg
 Peso: 2,30 kg (± 3%)
 Área de Gravação (silk): 14 x 14 cm

CADEIRA BISTRÔ VAZADA

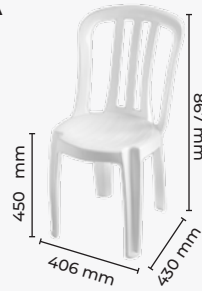

Suporta até 182 kg
 Peso: 2,25 kg (± 3%)

POLTRONA PÉGASUS



Suporta até 182 kg
 Peso: 2,75 kg (± 3%)
 Área de Gravação (silk): 17 x 25 cm

MESA QUADRADA MONOBLOCO

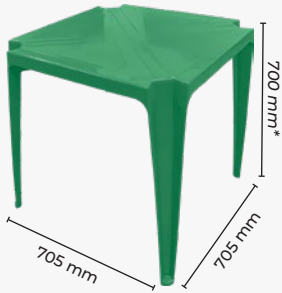

Área de Gravação (silk):
 Tampo: 4 partes de 15 x 15 cm | Lateral: 34 x 3 cm (4 lados)
 Peso: 3,800 a 4,100 kg



Garrafeiras

CTG 9

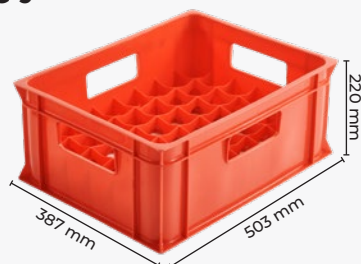

48 garrafas de 200 ml
Peso: 1,90 kg (± 3%)

CTG 3

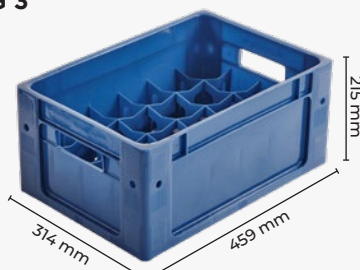

24 garrafas de 300 ml
Peso: 1,60 kg (± 3%)

CTG 3B

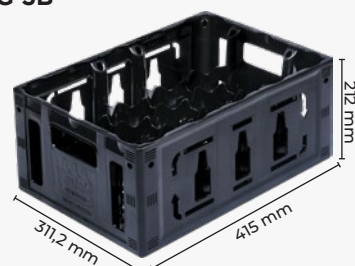

23 garrafas de 300 ml
Peso: 1,62 kg (± 3%)

CTG 4

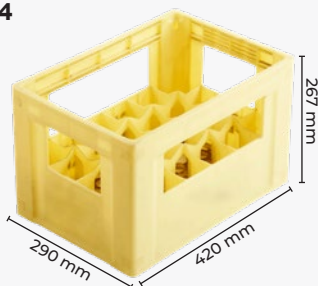

24 garrafas de 300 ml
Peso: 1,65 kg (± 3%)

CTG 7



24 garrafas de 300 ml
(Parede Alta)
Peso: 1,60 kg (± 3%)

CTG 10 KS ULTRA

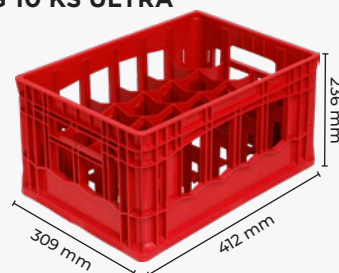

24 garrafas de 290 ml
(Parede Alta)
Peso: 1,44 kg (± 3%)

CTG 1



24 garrafas de 600 ml
Peso: 2,68 kg (± 3%)

CTG 2



12 garrafas de 600 ml ou 1 l
Peso: 1,60 kg (± 3%)

CTG 15

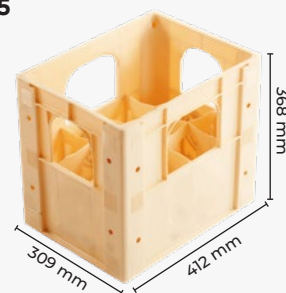

12 garrafas de 1 l
Peso: 2,20 kg (± 3%)

CTG 17

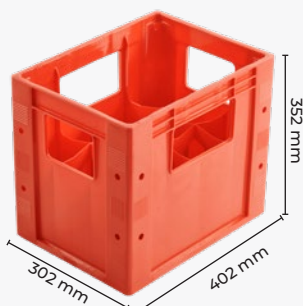

12 garrafas de 1 l
Peso: 2,25 kg (± 3%)

CTG 13

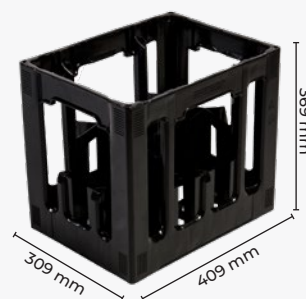

12 garrafas de 1,5 l
Peso: 2,30 kg (± 3%)

CTG 16

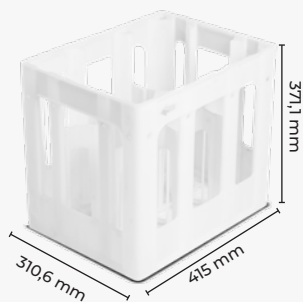

9 garrafas de 2 l
Peso: 2,30 kg (± 3%)

CTG 20



Garrafão (18 a 20 l)
Peso: 2,14 kg (± 3%)



Térmicos

LATAS



269 ml

355 ml

473 ml

LITRINHO



300 ml

BINECK



355 ml

MOD. 1



MOD. 2



MOD. 3



MOD. 4



600 ml

MOD. 1



MOD. 3



LITRÃO



Litro

Paleta Estrado

ESTRADO SMART

ED 2525

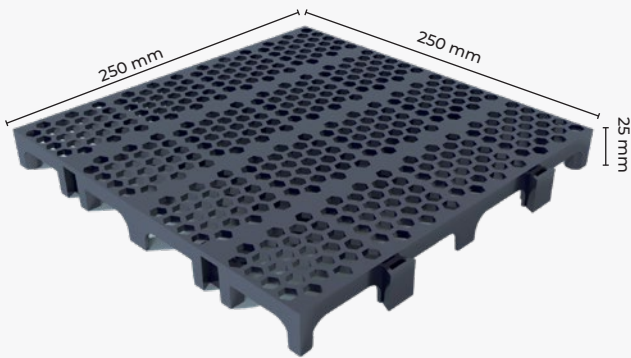

Peso: 0,200 kg

Carga Estática: 5.000 kg

Quantidade Necessária para 1 m²: 16 unidades

ESTRADO HEAVY

ED 5050

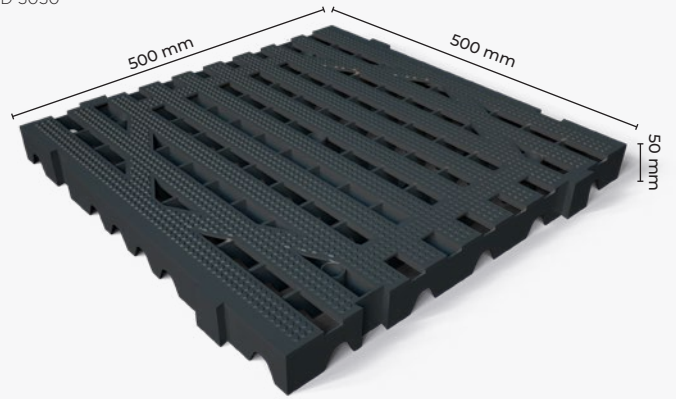

Peso: 1,2 kg

Carga Estática: 10.000 kg

Quantidade Necessária para 1 m²: 4 unidades

ESTRADO MULTI

ED 2550

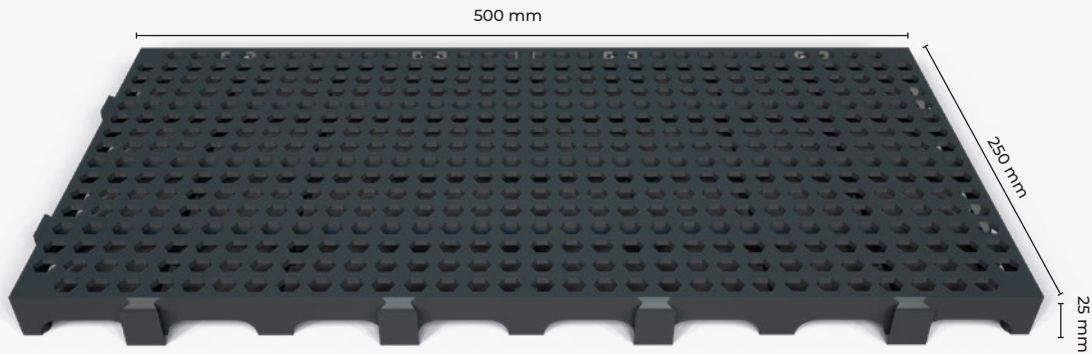

Carga Estática: 3.500 kg

Quantidade Necessária para 1 m²: 8 unidades

Peso: 0,380 kg

Paleta Leve

ESTRADO EXPORTAÇÃO

EX 1210

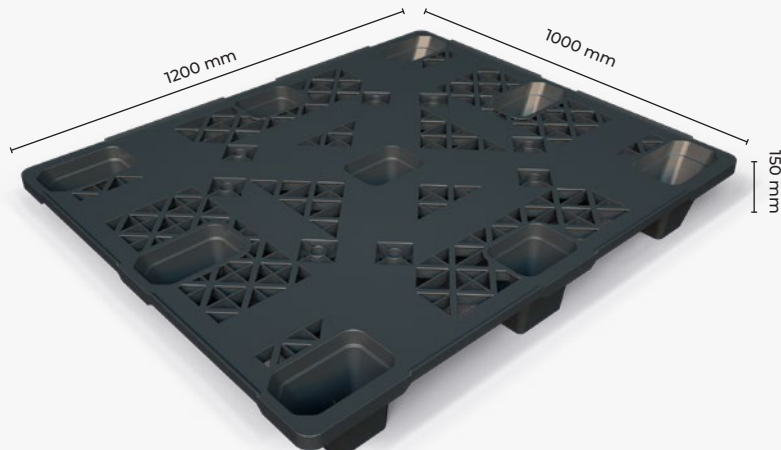

Peso: 8.5 kg

Carga Estática: 2.500 kg

Carga Dinâmica: 1.200 kg

Paleta Médio

PALETE MULTI

MD 1210

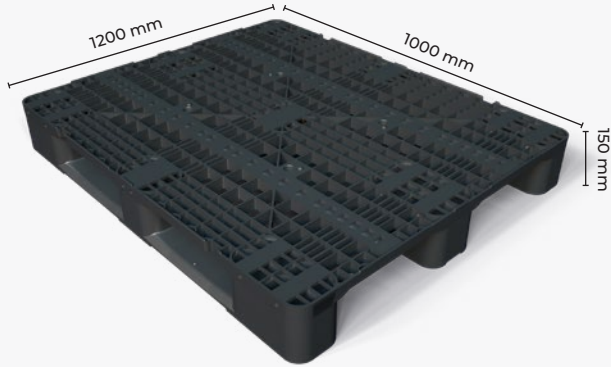

Carga Estática: 6.000 kg
Peso: 15 kg

Carga Dinâmica: 1.250 kg
Carga Rack: 800 kg

PALETE MULTI LISO

MDLS 1210

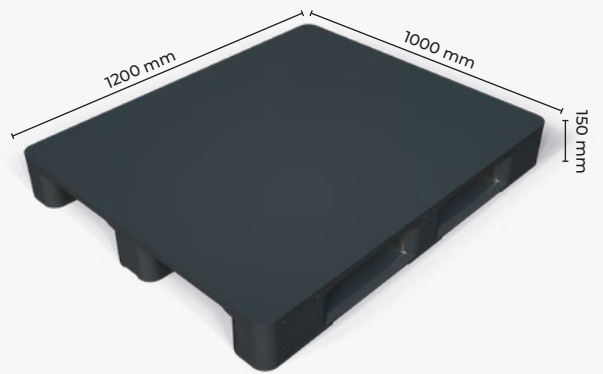

Carga Estática: 7.000 kg
Peso: 19 kg

Carga Dinâmica: 2.000 kg
Carga Rack: 900 kg

Paleta Pesado

PALETE PESADO 3R

HV3 1210

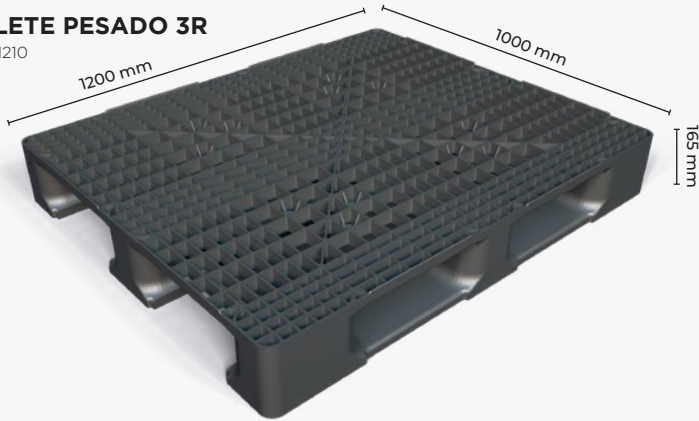

Carga Estática: 7.500 kg
Peso: 15 kg

Carga Dinâmica: 2.500 kg
Carga Rack: 850 kg

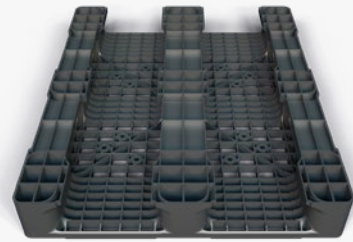

PALETE PESADO 6R

HV6 1210

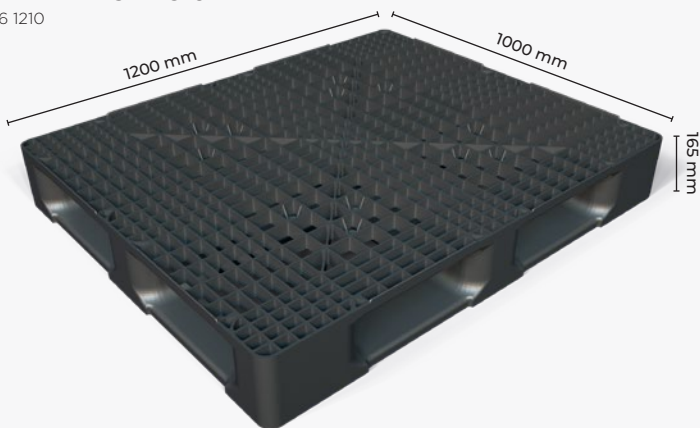

Carga Estática: 8.000 kg
Peso: 16,5 kg

Carga Dinâmica: 3.000 kg
Carga Rack: 1.000 kg

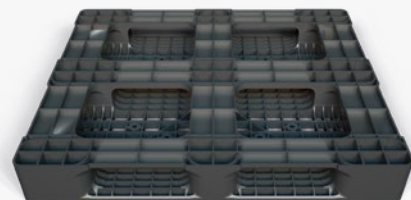

Paleta de Contenção

PALETE DE CONTENÇÃO 1T

CT1 TA



Capacidade: 110 l

PALETE DE CONTENÇÃO 2T

CT2 TA



Perfil Baixo

Dimensões: 1300 x 650 x 230 mm

Capacidade: 110 l

Perfil Médio

Dimensões: 1300 x 650 x 320 mm

Capacidade: 190 l

Perfil Alto

Dimensões: 1300 x 650 x 450 mm

Capacidade: 255 l

PALETE DE CONTENÇÃO 4T

CT4 TA

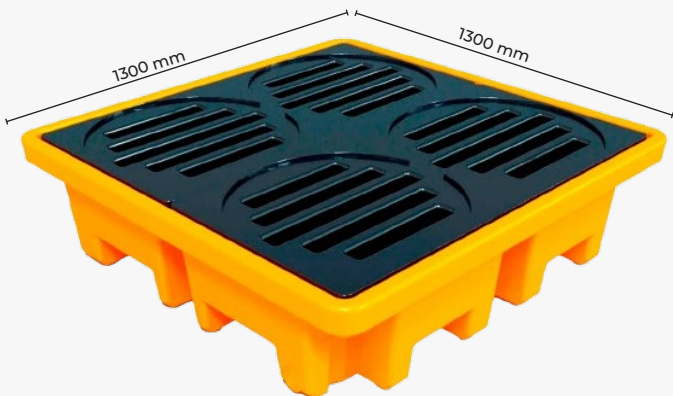

Perfil Baixo

Dimensões: 1300 x 1300 x 230 mm

Capacidade: 220 l

Perfil Médio

Dimensões: 1300 x 1300 x 320 mm

Capacidade: 380 l

Perfil Alto

Dimensões: 1300 x 1300 x 450 mm

Capacidade: 420 l



CENTRAL DE EMBALAGENS

ORGULHO EM PERTENCER

 www.centraldeembalagens.com.br



CONTATO

 (11) 98901-9276  (11) 3687-0311

 comercial@centraldeembalagens.com.br

ENDEREÇO

 **MATRIZ:** Rua Francisco Alves, 7 - Vila São José - Osasco - SP

 **BOITUVA:** Rua Benedito Mazulquim, 620 - Cidade Jardim - Boituva - SP

 **BAHIA:** Rod. Governador Mário Covas, S/N - Bairro 2 de Julho - Alagoinhas - BA

REDES SOCIAIS

 @centraldeembalagens

 CE - Central de Embalagens

 facebook.com/centraldeembalagens